

Product Sheet

Alles loopt op rolletjes!

Item No. ZWET D P E 1 C C 075 P 2 T 2 B 4 2

housing / data

housing type swivel castor with total brake
 series apparatus twin wheels
 fixing type fixing plate
 hole dimensions / hub width 77 x 67 mm
 thickness of fixing / fork 3.00 mm / 2.50 mm
 surface treatment zinc-chromatised



wheel / data

diameter 75 mm
 wheel center Polypropylene grey
 wheel tread thermopl. rubber 95° Shore A grey
 bearing single ball bearing
 threadguard full covering plastic threadguard
 hub width 56 mm
 axle diameter M8
 temperature range -20°C - +60°C
 dyn. load capacity 100 kg

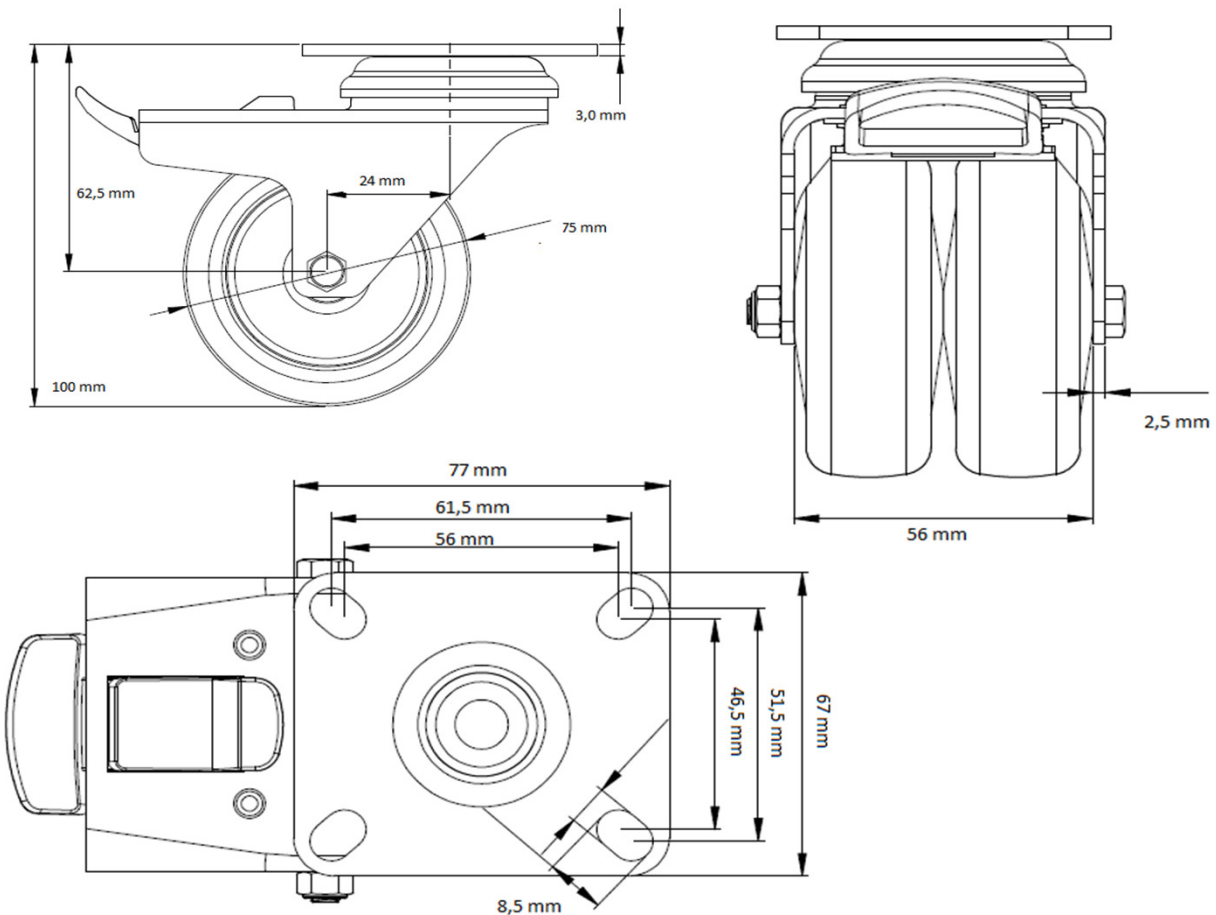

Alles loopt op rolletjes!