

Product Sheet

Item No. F H P 5 L W C 125 Z 0 Z 0 D 0 N

housing / data

housing type	fixed castor
series	heavy duty
fixing type	fixing plate
hole dimensions / hub width	105 x 80 mm / 60 mm
thickness of fixing / fork	5.00 mm / 5.00 mm
surface treatment	galvanized blue zinc



wheel / data

diameter	125 mm
wheel center	Polyamide (Heavy Duty) white
wheel tread	Polyamide (Heavy Duty) white
bearing	double ball bearing
threadguard	no separate threadguard
hub width	60 mm
axle diameter	M 12
temperature range	-40°C - +80°C
dyn. load capacity	500 kg

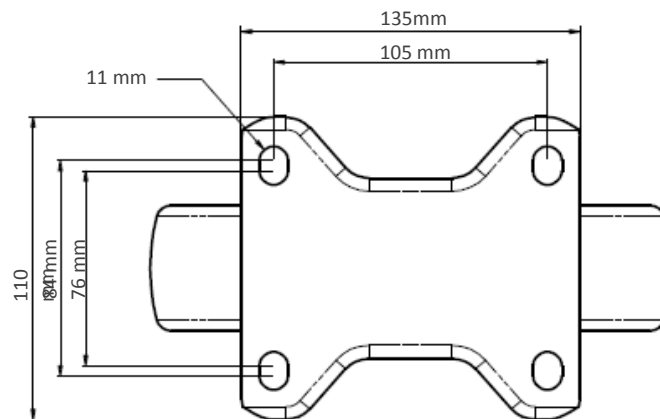
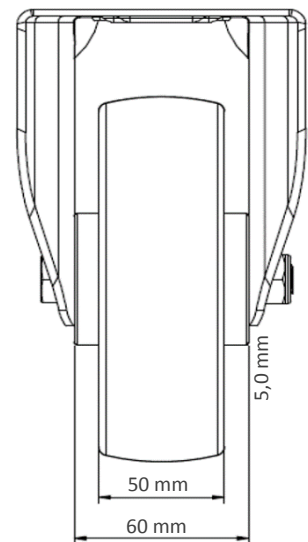
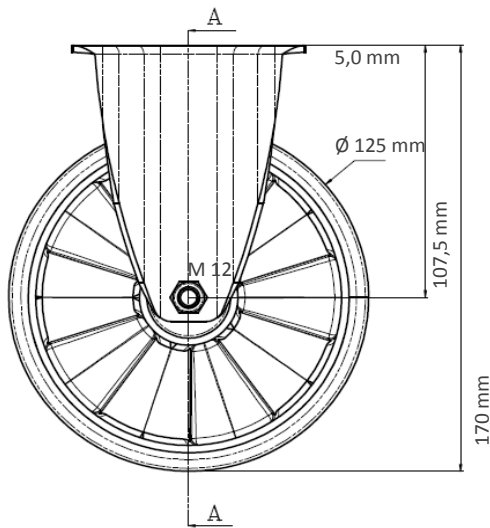
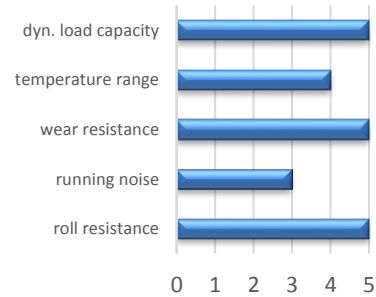

Deviation possible! All information is subject to change.