

# Product Sheet

Item No. T I P 2 6 S C 080 N 2 U 6 Q 0 N

## housing / data

housing type swivel castor with total brake

fixing type fixing plate  
 hole dimensions / hub width 80 x 60 mm / 42 mm  
 thickness of fixing / fork 2.50 mm / 2.00 mm  
 surface treatment stainless steel



## wheel / data

diameter 80 mm  
 wheel center Polyamide grey  
 wheel tread Polyurethane red  
 bearing roller bearing (stainless steel)  
 threadguard no separate threadguard  
 hub width 40 mm  
 axle diameter M8  
 temperature range -40°C - +80°C  
 dyn. load capacity 130 kg

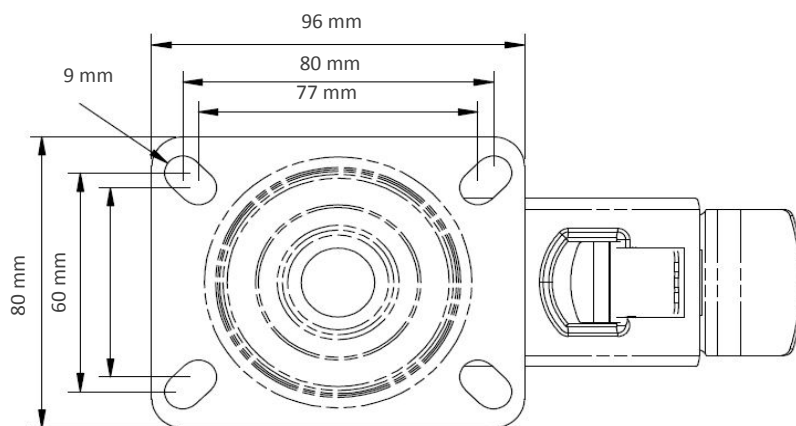
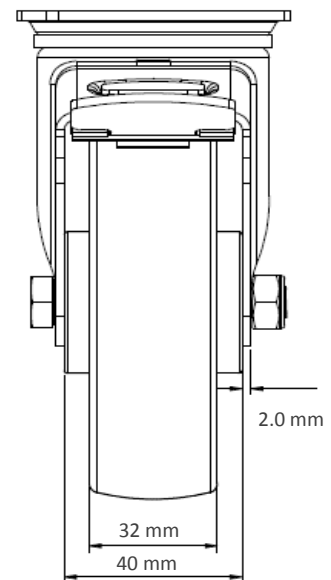
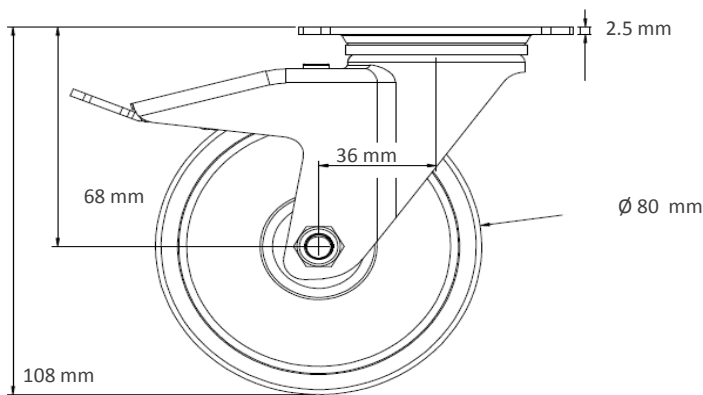
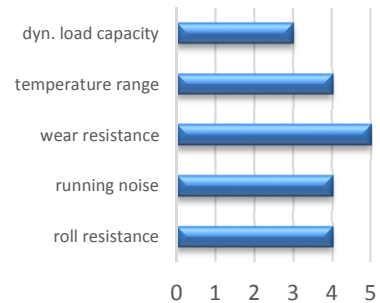

Deviation possible! All information is subject to change.