

Product Sheet

Item No. F I P 2 2 S C 100 N 2 U 6 Q 0 N

housing / data

housing type	fixed castor
fixing type	fixing plate
hole dimensions / hub width	80 x 60 mm / 42 mm
thickness of fixing / fork	2.00 mm / 2.00 mm
surface treatment	stainless steel



wheel / data

diameter	100 mm
wheel center	Polyamide grey
wheel tread	Polyurethane red
bearing	roller bearing (stainless steel)
threadguard	no separate threadguard
hub width	40 mm
axle diameter	M 8
temperature range	-40°C - +80°C
dyn. load capacity	150 kg

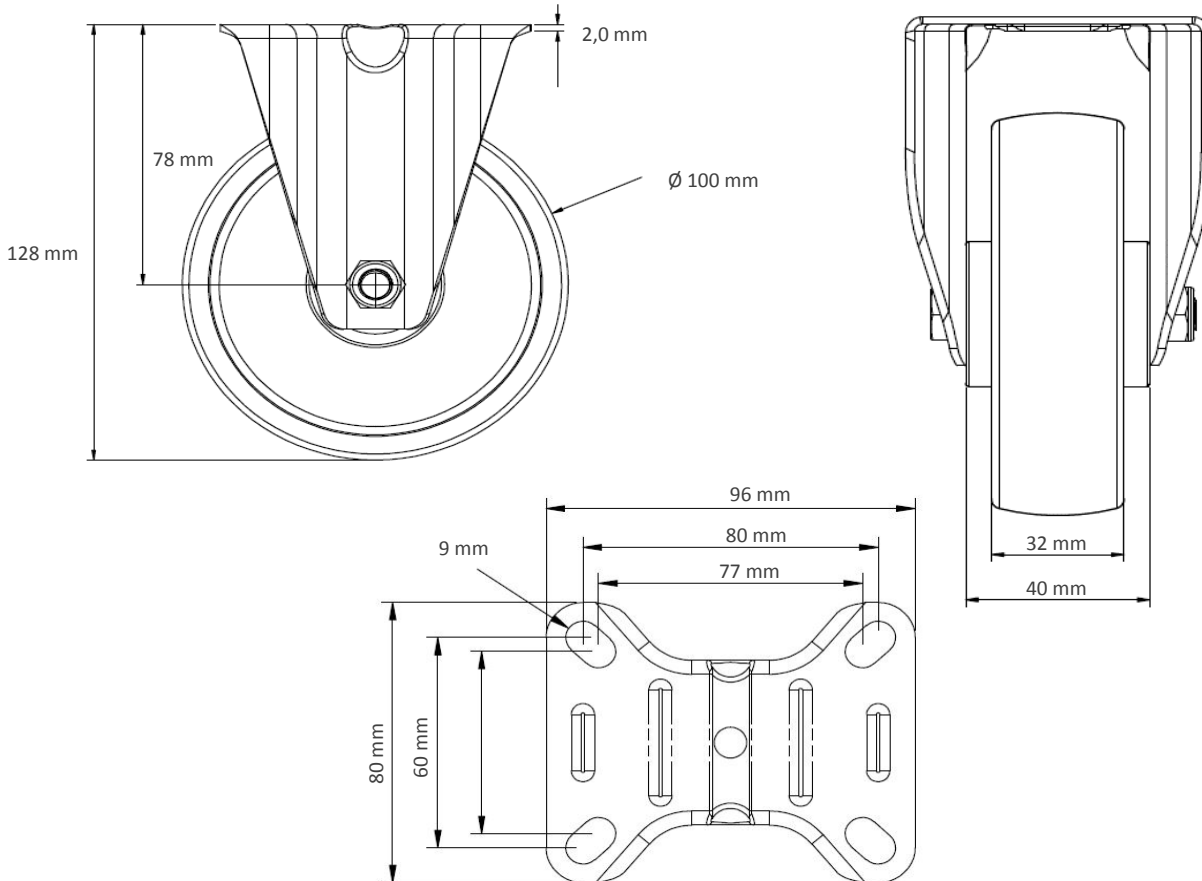
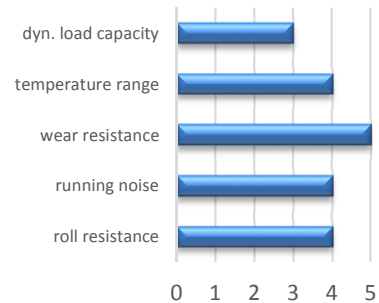

Deviation possible! All information is subject to change.